

Single phase hybrid inverters

ASW H-S2 SERIES

User Manual

ASW3000 / 3680 / 4000 / 5000 / 6000-H-S2

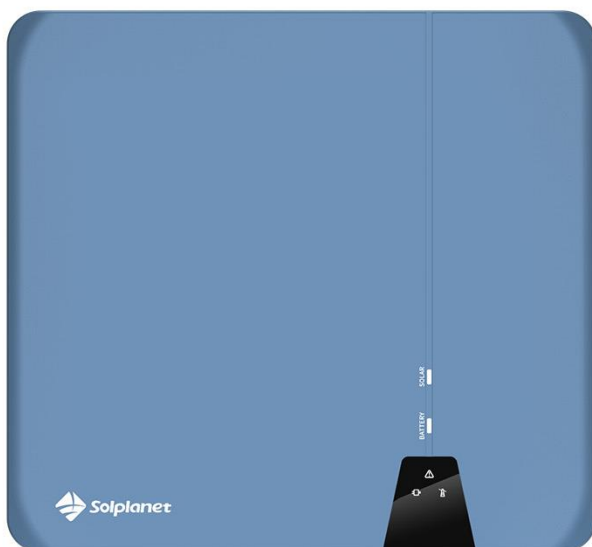

Solplanet inverter Table of Contents

1	Notes on this Manual	5
1.1	General Notes	5
1.2	Area of validity	5
1.3	Target group	6
1.4	Symbols used in this manual	7
2	Safety	8
2.1	Intended use	8
2.2	Important safety information	9
2.3	Symbols on the label	11
3	Unpacking	13
3.1	Scope of delivery	13
3.2	Checking for transport damage	14
4	Mounting	15
4.1	Requirements for mounting	15
4.2	Mounting the inverter	17
5	system solution	19
5.1	system solution	19
5.2	System wiring diagram	20
5.3	Working mode	21
5.3.1	Self-Consumption	21
5.3.2	Back-up	23
5.3.3	Force time use custom	25
5.3.4	Off-GRID	26
6	Electrical Connection	27

6.1 Safety	27
6.2 System layout of units without integrated DC switch.....	28
6.3 Overview of the connection area.....	29
6.4 AC connection.....	29
6.4.1 Conditions for the AC connection	30
6.4.2 Grid connection	34
6.5 EPS connection	36
6.6 Second protective grounding connection	38
6.7 DC Connection.....	39
6.7.1 Requirements for the DC Connection	39
6.7.2 Assembling the DC connectors	40
6.7.3 Connecting the PV array.....	42
6.8 Battery connection	43
6.9 Communication equipment connection	45
6.9.1 Communication.....	46
6.9.2 BMS CAN cable connection.....	46
6.9.3 DRED cable connection	47
6.9.4 Smart meter cable connection	48
6.9.5 WiFi connection.....	50
7 Communication	51
7.1 System monitoring via WLAN	51
7.2 Inverter demand response modes (DRED)	51
7.3 Earth Fault Alarm	52
8 Commissioning	53
8.1 Electrical checks	53
8.2 Mechanical checks.....	55
8.3 Safety code check.....	55

8.4 Start-Up.....	57
8.4.1 Smart meter set-up.....	57
8.4.2 Initialization set-up.....	57
8.4.3 Starting conditions of different modes.....	57
8.4.4 Description of working state.....	58
9 Display	59
9.1 Overview of the panel	59
9.1.1 LEDs.....	60
10 Disconnecting the Inverter from Voltage Sources	62
11 Technical Data	64
11.1 DC input data	64
11.2 Battery input data.....	65
11.3 Grid AC output data	66
11.4 Grid AC input data.....	67
11.5 EPS output data.....	68
11.6 General data	69
11.7 Safety regulations	70
11.8 Efficiency.....	71
11.9 Power reduction	75
11.9.1 Power reduction with increased ambient temperature (ASW3000H-S2)	76
11.9.2 Power reduction with increased ambient temperature (ASW3680H-S2)	76
11.9.3 Power reduction with increased ambient temperature (ASW4000H-S2)	77
11.9.4 Power reduction with increased ambient temperature (ASW5000H-S2)	77

11.9.5 Power reduction with increased ambient temperature (ASW6000H-S2)	78
11.10 Tools and torque	79
12 Troubleshooting	81
13 Maintenance	84
13.1 Cleaning the contacts of the DC switch.....	84
13.2 Cleaning the heat sink.....	84
14 Recycling and disposal	85
15 EU Declaration of Conformity.....	85
16 Warranty	86
17 Contact.....	87

1 Notes on this Manual

1.1 General Notes

Solplanet hybrid inverter is a high-quality inverter which can convert solar energy to AC energy and store energy into battery. The energy produced from the inverter shall be used to optimize self-consumption, then charge battery, exceed power could export to grid. Loads will be supported in priority by the system, then battery power, exceed consumption power will be drained from grid inverter. It can provide power for emergency use during the grid lost by using the energy from battery and inverter(generated from PV).

1.2 Area of validity

This manual describes mounting, installation, commissioning and maintenance of the following Solplanet hybrid inverters:

ASW3000H-S2

ASW3680H-S2

ASW4000H-S2

ASW5000H-S2

ASW6000H-S2

Observe all documentation that accompanies the inverter. Keep them in a convenient place and available at all times.

1.3 Target group

This manual is for qualified electricians only, who must perform the tasks exactly as described.

All persons installing inverters must be trained and experienced in general safety which must be observed when working on electrical equipments. Installation personnel should also be familiar with local requirements, rules and regulations.

Qualified persons must have the following skills:

- Knowledge of how an inverter works and is operated
- Training in how to deal with the dangers and risks associated with installing, repairing and using electrical devices and installations
- Training in the installation and commissioning of electrical devices.
- Knowledge of all applicable laws, standards and directives
- Knowledge of and compliance with this document and all safety information.

1.4 Symbols used in this manual

Safety instructions will be highlighted with the following symbols:

 **DANGER**

DANGER indicates a hazardous situation which, if not be avoided, will result in death or serious injury.

 **WARNING**

WARNING indicates a hazardous situation which, if not be avoided, can result in death or serious injury.

 **CAUTION**

CAUTION indicates a hazardous situation which, if not be avoided, can result in minor or moderate injury.

NOTICE

NOTICE indicates a situation which, if not be avoided, can



INFORMATION that is important for a specific topic or goal, but is not safety-relevant.

2 Safety

2.1 Intended use

1. The inverter is suitable for indoor and outdoor use.
2. The inverter must only be operated with PV arrays (PV modules and cabling) of protection class II, in accordance with IEC 61730, application class A.
3. PV modules with a high capacitance to ground must only be used if their coupling capacitance is less than $1.5\mu\text{F}$.
4. When the PV modules are exposed to sunlight, a DC voltage is supplied to this inverter.
5. When designing the PV system, ensure that the values comply with the permitted operating range of all components at all times.
6. Battery negative(BAT-) on inveter side is not grounded as default design. Connecting BAT- to EARTH are strictly forbidden.
7. The battery used together with the inverter must only be that is approved or released by AISWEI as shown on Datasheet.
8. The inverter must only be used in countries for which it is approved or released by AISWEI and the grid operator.
9. Use this inverter only in accordance with the information provided in this documentation and with the locally applicable standards and directives.
10. The type label must remain permanently attached to the product.
11. The inverters shall not be used in multiple phase combinations.

WARNING

Danger to life due to electric shock when live components or cables are touched

- All work on the inverter must only be carried out by qualified personnel who have read and fully understood all safety information contained in this manual.
- Do not open the product.
- Children must be supervised to ensure that they do not play with this device.

WARNING

Danger to life due to high voltages of the PV array

When exposed to sunlight, the PV array generates dangerous DC voltage which is present in the DC conductors and the live components of the inverter. Touching the DC conductors or the live components can lead to lethal electric shocks. If you disconnect the DC connectors from the inverter under load, an electric arc may occur leading to electric shock and burns.

- Do not touch non-insulated cable ends.
- Do not touch the DC conductors.
- Do not touch any live components of the inverter.
- Have the inverter mounted, installed and commissioned only by qualified persons with the appropriate skills.
- If an error occurs, have it rectified by qualified persons only.
- Prior to performing any work on the inverter, disconnect it from all voltage sources as described in this document (see Section 9 "Disconnecting the Inverter from Voltage Sources").



WARNING

Risk of injury due to electric shock

Touching an ungrounded PV module or array frame can cause a lethal electric shock.

- connect and ground the PV modules, array frame and electrically conductive surfaces so that there is continuous conduction.



WARNING

Risk of fire due to the electric power

Batteries deliver electric power, resulting in burns or a fire hazard when they are short circuited, or wrongly installed.

- Do not wear watches, rings or similar metallic items during battery replacement.
- Use insulated tools.
- Put on rubber shoes and gloves.
- Do not place metallic tools and similar metallic parts on the batteries.
- Switch off load connected to the batteries before dismantling battery connection terminals.







NOTICE



Risk of burns due to hot enclosure parts

Some parts of the enclosure can get hot during operation.

- During operation, do not touch any parts except the enclosure lid of the inverter.

2.3 Symbols on the label

Symbol	Explanation
	<p>Beware of a danger zone</p> <p>This symbol indicates that the product must be additionally grounded if additional grounding or equipotential bonding is required at the installation site.</p>
	<p>Beware of high voltage and operating current</p> <p>The inverter operates at high voltage and current. Work on the inverter must only be carried out by skilled and authorized electricians.</p>
	<p>Beware of hot surfaces</p> <p>The inverter can get hot during operation. Avoid contact during operation.</p>
	<p>WEEE designation</p> <p>Do not dispose of the product together with the household waste but in accordance with the disposal regulations for electronic waste applicable at the installation site.</p>
	<p>CE marking</p> <p>The product complies with the requirements of the applicable EU directives.</p>
	<p>Certification mark</p> <p>The product has been tested by TUV and got the quality certification mark.</p>
	<p>RCM Mark</p> <p>The product complies with the requirements of the applicable Australian standards.</p>

	<p>Capacitors discharge Before opening the covers, the inverter must be disconnected from the grid and PV array. Wait at least 5 minutes to allow the energy storage capacitors to fully discharge.</p>
	<p>Observe the documentation Observev all documentation supplied with the product</p>

3 Unpacking

3.1 Scope of delivery

Object	Description	Quantity
A	Inverter	1 piece
B	Wall mounting bracket	1 piece
C	Screw accessory	1 set
D	Documentation	1 set
E	DC connector	2 pairs
F	WiFi stick	1 piece
G	Battery terminal cover	1 set
H	AC connector	2 pieces
I	Smart meter	1 piece
J	RS485 Communication client	3 pieces

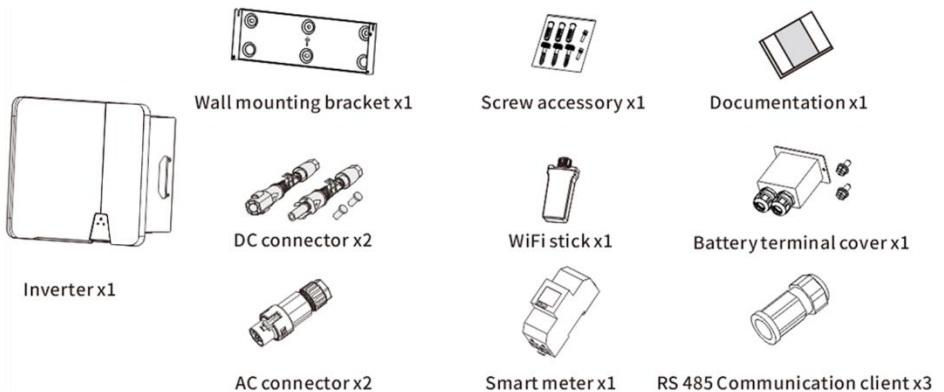

Carefully check all of the components in the carton. If anything is missing, contact your dealer.

3.2 Checking for transport damage

Thoroughly inspect the packaging upon delivery. If you detect any damage to the packaging which indicates the inverter may have been damaged, inform the responsible shipping company immediately. We will be glad to assist you if required.

4 Mounting

4.1 Requirements for mounting

WARNING

Danger to life due to fire or explosion

Despite careful construction, electrical devices can cause fires.

- Do not mount the inverter on flammable construction materials.
- Do not mount the inverter in areas where flammable materials are stored.
- Do not mount the inverter in areas where there is a risk of explosion.

1. Ensure that the inverter is installed out of the reach of children.
2. Install the inverter in a high traffic area where the fault is likely to be seen.
3. To ensure best operating status and prolonged service life, the mounting ambient temperature of the inverter should be $\leq 45^{\circ}\text{C}$.
4. To avoid direct sunlight, rain, snow, ponding on the inverter, it is suggested to mount the inverter in places with a top protective roof. Do not completely cover the top of the inverter.



5. The mounting condition must be suitable for the weight and size of the inverter. The inverter is suitable to be mounted on solid wall that is vertical or tilted backwards (Max. 15°). It is not recommended to install the inverter on the wall made of plasterboards or similar materials. The inverter may make noise when working.

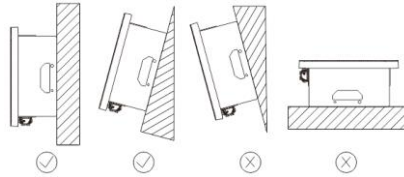

6. To ensure adequate heat dissipation, the clearances between the inverter and other objects are recommended as follows:

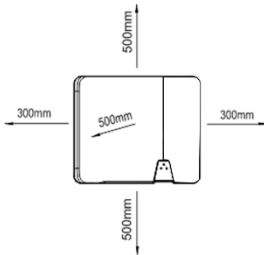

Direction	Min. clearance (mm)
above	500
below	500
sides	300

Clearances for one inverter

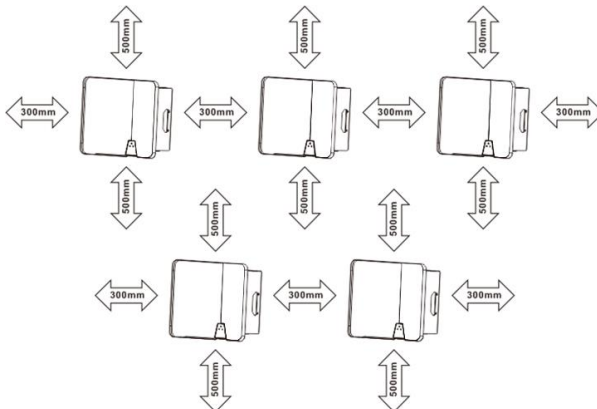

Clearances for multiple inverters

4.2 Mounting the inverter

⚠ CAUTION

Risk of injury when lifting the inverter, or if it is dropped

The weight of Solplanet inverter is max. 25.1 kg. There is risk of injury if the inverter is lifted incorrectly or dropped while being transported or when attaching it to or removing it from the wall bracket.

- Transport and lift the inverter carefully.

Mounting procedure:

⚠ CAUTION

Risk of injury due to damaged cables

There may be power cables or other supply lines (e.g. gas or water) routed in the wall.

- Ensure that no lines are laid in the wall which could be damaged when drilling holes.

1. Use a $\Phi 10$ mm bit to drill 3 holes at a depth of about 70mm according to the location of the wall mounting bracket.

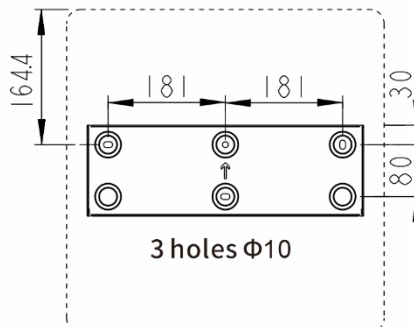

CAUTION

Risk of injury due to the inverter falls down

If the depth and distance of the holes is not correct, the inverter maybe fall down from the wall.

- Before inserting the wall anchors, measure the depth and distance of the holes.

2. Insert wall plugs into the wall and fix the wall mounting bracket to the wall by screwing three self-tapping screws (SW10).

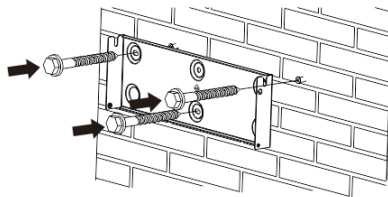

3. Hang the inverter to the wall mounting bracket. Secure the inverter to the wall mounting bracket on both sides using M5 screws.

Screwdriver type: PH2, torque: 2.5Nm.

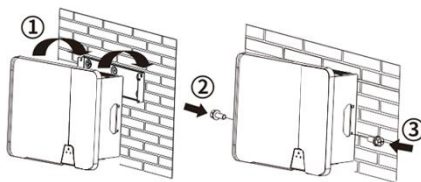

4. To protect the inverter from theft, attach the padlock provided by customer through the wall mounting bracket and the inverter.

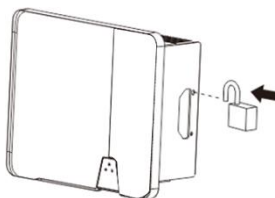

5 system solution

ASW3000H-S2/ ASW3680H-S2/ ASW4000H-S2/ ASW5000H-S2/ ASW6000H-S2 is a single-phase hybrid inverter applicable to on-grid PV systems and also backup mode. With the integrated Energy Management System (EMS), they can control and optimize the energy flow in order to increase the self-consumption of the system.

5.1 system solution

The photovoltaic energy storage power generation system is composed of the following parts.

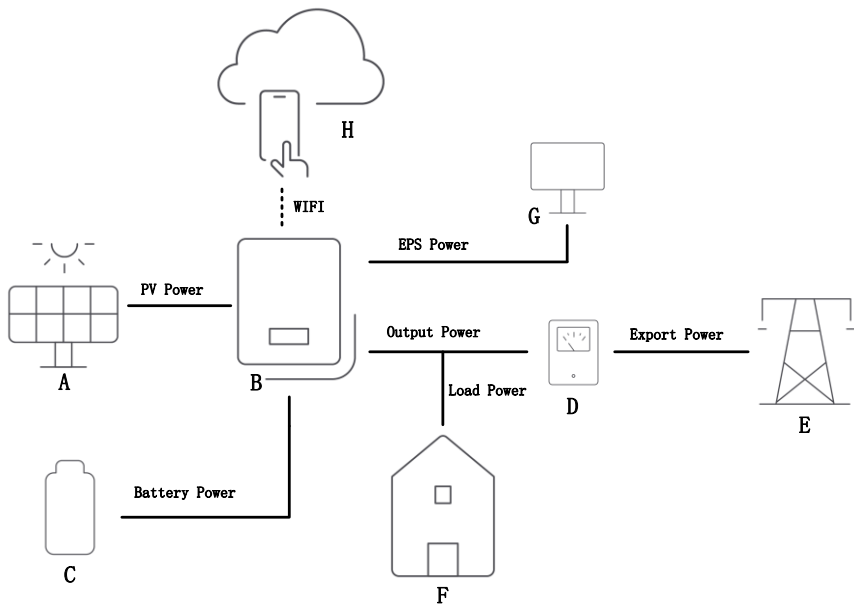

Item	part	function
A	Photovoltaic panel	Photovoltaic power generation
B	inveter	energy conversion
C	battery	Energy storage
D	meter	Grid energy control
E	GRID	Public power grid
F	Back-up load	Uninterrupted power equipment
G	Normal load	General electrical equipment
H	APP	Inverter setting and display

5.2 System wiring diagram

Australia

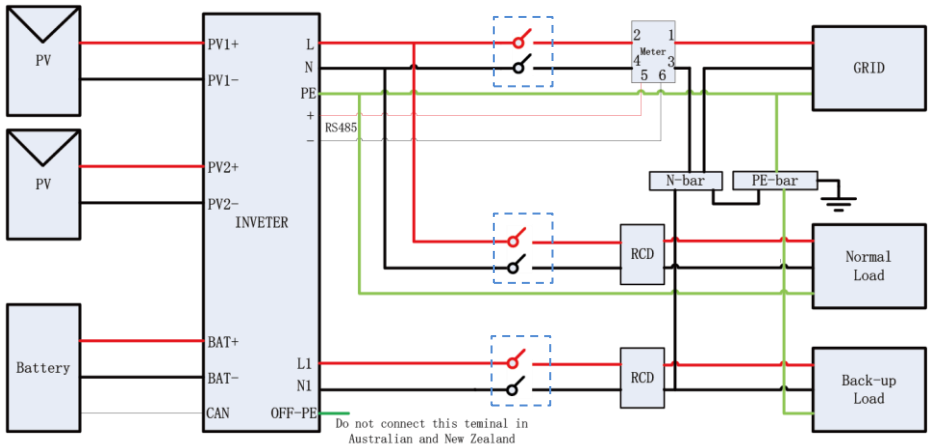



According to Australian safety requirement, the neutral cables of the on-grid side and back-up side must be connected together. And the OFF-PE terminal don't need be connected. Otherwise, the hybrid inverter will not work.

Europe

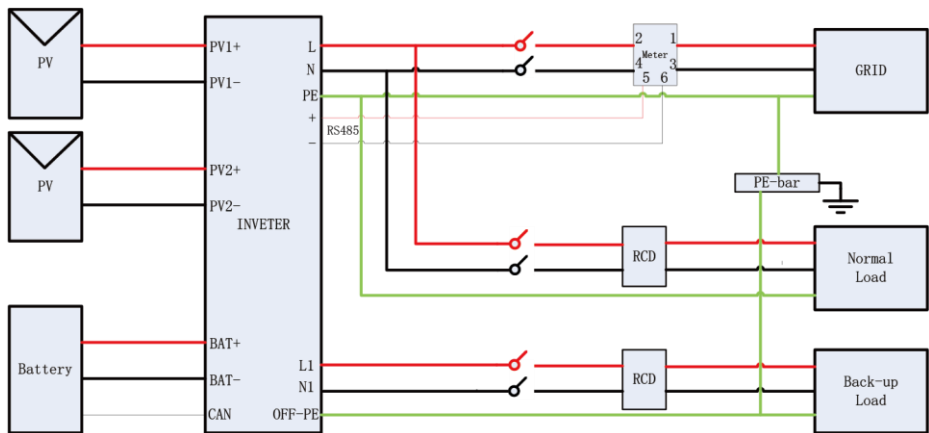

5.3 Working mode

There are four working modes of energy storage inverter, Self-Consumption, Backup, Force time use Custom, Off-grid. If mode switching is in operation, please stop the inverter first.

5.3.1 Self-Consumption

The photovoltaic energy is preferentially used by local load to improve the self-consumption rate and self-sufficiency rate.

Load priority: load>battery>GRID

When the photovoltaic energy is enough, first supply power to the load, then charge the battery, and finally exported to the grid.

Power priority: PV > battery > GRID

When the load power is too large, first from the photovoltaic energy, and then battery discharge, and finally consume the power from the grid.

- 1) In the morning, the photovoltaic energy is insufficient, and the load is powered by PV, battery and the grid.

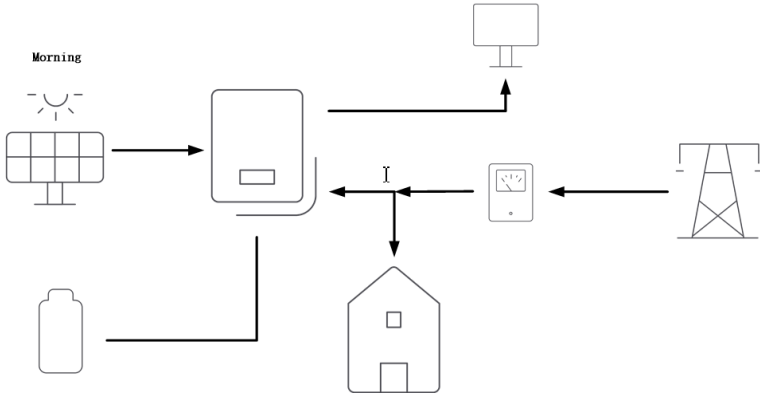

- 2) In the afternoon, the photovoltaic energy is sufficient, the load is powered by photovoltaic, the battery is charged, and finally exported to the grid.

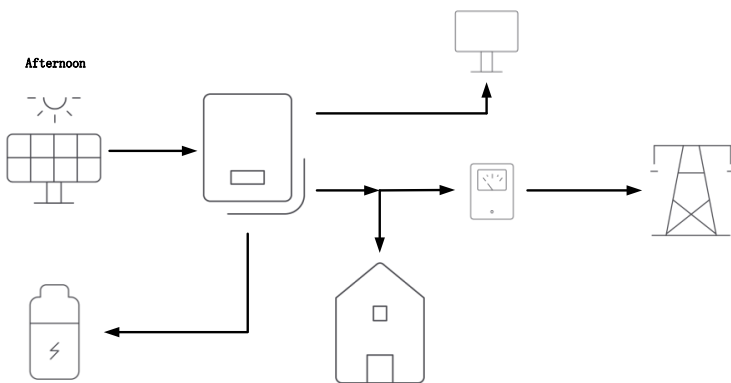

- 3) At night, there is no photovoltaic, and the battery supplies power to the load.

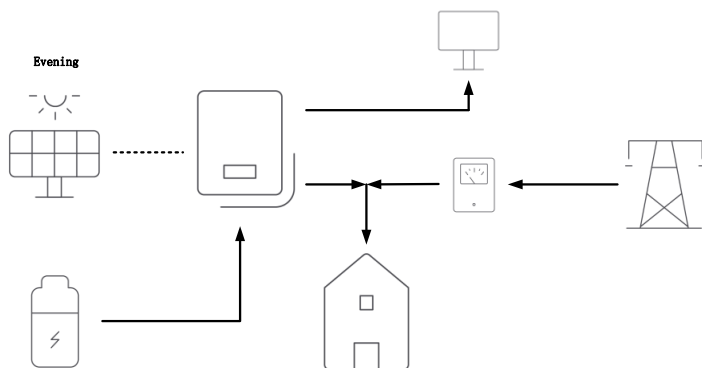

- 4) In case of the grid failure, switch to off grid, and off grid load can still work normally

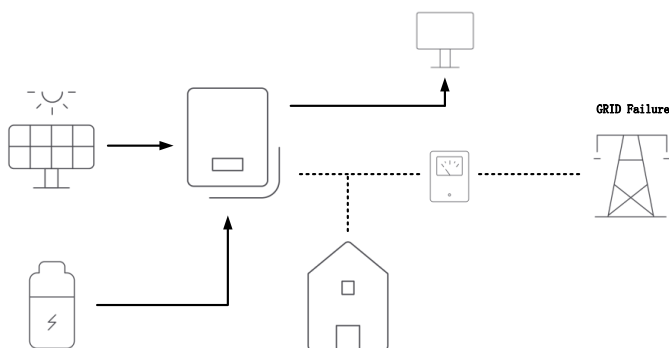

5.3.2 Back-up

Battery as a backup power supply, always keep sufficient energy, power supply to the load when PV energy is insufficient and GRID failure.

Load priority when Grid failure: load>battery

When Grid is failure, photovoltaic energy as the power source, first supply power to the load ,then charge the battery.

Load priority when Grid normal: battery>load>Grid

When Grid is normal and photovoltaic energy is sufficient, PV first charge the battery, then supply power to the load, and finally exported to the grid.

Power priority: PV>Grid>Battery

When the load power is too large, first from the photovoltaic energy, and then consume the power from the grid. Under normal conditions, the battery does not discharge, only in the event of PV energy is insufficient and GRID failure, battery as a backup power supply to the load.

1) Photovoltaic priority to charge the battery.

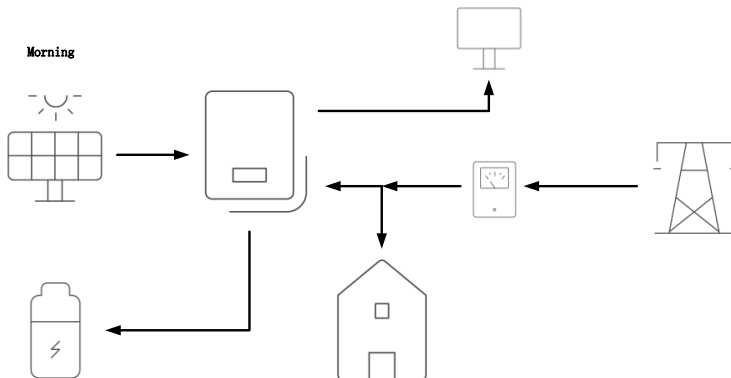

2) Under normal conditions, the battery does not discharge, Even at night.

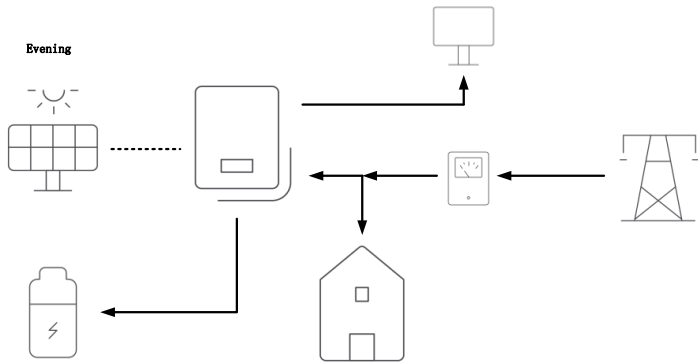

3) When GRID failure and PV energy is insufficient, the battery supplies power to the load.

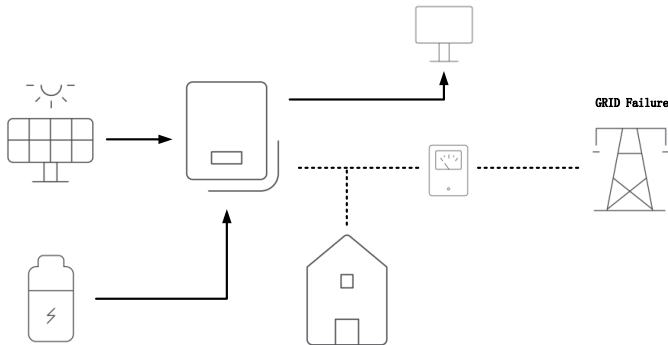

5.3.3 Force time use custom

Users can manage the energy according to their own needs, and set the daily regular charging and discharging on the app. Other time follow the Self-Consumption mode

5.3.4 Off-GRID

The inverter operates off the grid, no matter whether the grid has power or not.

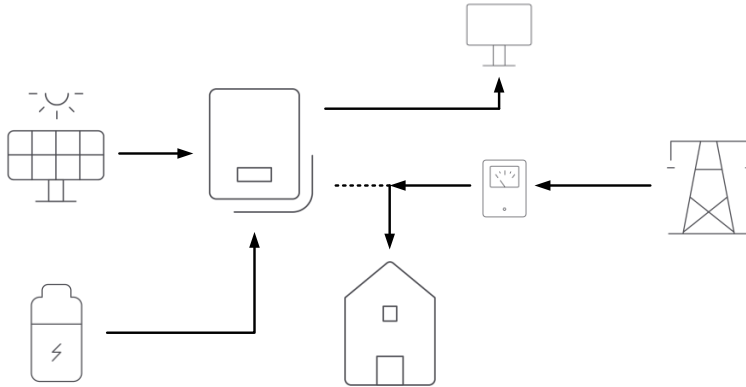

6 Electrical Connection

6.1 Safety

DANGER

Danger to life due to high voltages of the PV array

When exposed to sunlight, the PV array generates dangerous DC voltage which is present in the DC conductors and the live components of the inverter. Touching the DC conductors or the live components can lead to lethal electric shocks. If you disconnect the DC connectors from the inverter under load, an electric arc may occur leading to electric shock and burns.

- Do not touch non-insulated cable ends.
- Do not touch the DC conductors.
- Do not touch any live components of the inverter.
- Have the inverter mounted, installed and commissioned only by qualified persons with the appropriate skills.
- If an error occurs, have it rectified by qualified persons only.
- Prior to performing any work on the inverter, disconnect it from all voltage sources as described in this document (see Section 9 "Disconnecting the Inverter from Voltage Sources").

WARNING

Risk of injury due to electric shock

- The inverter must be installed only by trained and authorized electricians.
- All electrical installations must be done in accordance with the National Wiring Rules standards and all locally applicable standards and directives.

NOTICE

Damage to the inverter due to electrostatic discharge

- Touching electronic components can cause damage to or destroy the inverter through electrostatic discharge.
- Ground yourself before touching any component.

6.2 System layout of units without integrated DC switch

Local standards or codes may require that PV systems are fitted with an external DC switch on the DC side. The DC switch must be able to safely disconnect the open-circuit voltage of the PV array plus a safety reserve of 20%.

Install a DC switch to each PV string to isolate the DC side of the inverter. We recommend the following electrical connection:

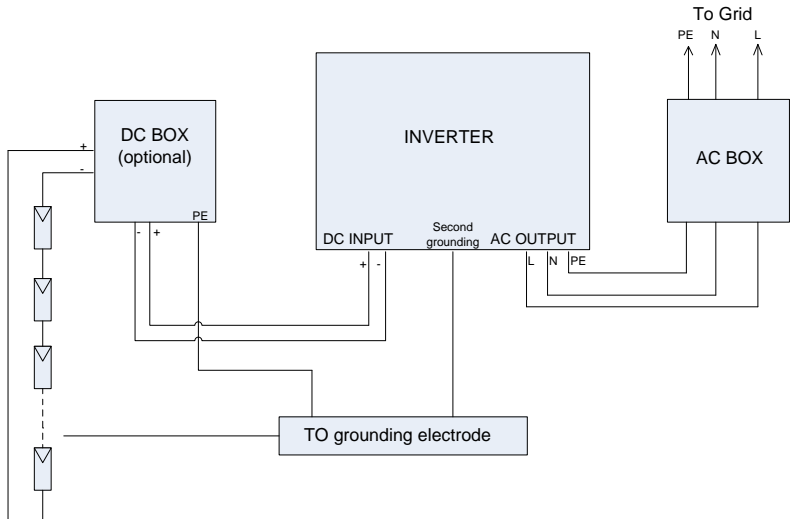

6.3 Overview of the connection area

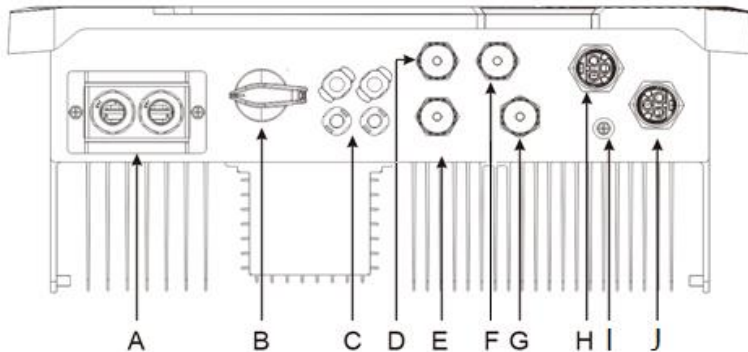

Object	Description
A	Battery terminal cover
B	DC-switch
C	PV input
D	BMS: BMS communication port
E	METER: Merter communication port
F	DRED: DRMs device port
G	COM1: Wi-Fi Stick port
H	EPS connector
I	Additional greounding screw
J	AC connector

6.4 AC connection

DANGER

Danger to life due to high voltages in the inverter

- Before establishing the electrical connection, ensure that the miniature circuit-breaker is switched off and cannot be reactivated.

6.4.1 Conditions for the AC connection

Cable Requirements

The grid connection is established using three conductors (L, N, and PE).

We recommend the following specifications for stranded copper wire.

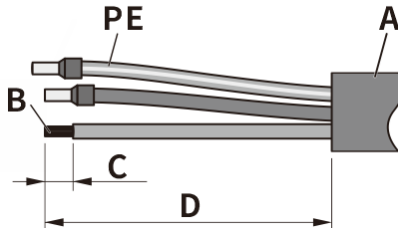

ASW3000H-S2/3680H-S2/4000H-S2/5000H-S2/6000H-S2

Object	Description	Value
A	External diameter	10 to 16 mm
B	Conductor cross-section	4 to 6 mm ²
C	Stripping length of the insulated conductors	approx. 13 mm
D	Stripping length of the outer sheath of AC cable	approx. 53 mm
The PE conductor must be 2mm longer than the L and N conductors		

Larger cross-sections should be used for longer cables.

Cable design

The conductor cross-section should be dimensioned to avoid power loss in cables exceeding 1% of rated output power.

The higher grid impedance of the AC cable makes it easier to disconnect from the grid due to excessive voltage at the feed-in point.

The maximum cable lengths depend on the conductor cross-section as follows:

Conductor cross-section	Maximum cable length				
	ASW3000 H-S2	ASW3680 H-S2	ASW4000 H-S2	ASW5000 H-S2	ASW6000 H-S2
2.5 mm ²	46m	37 m	28 m	17 m	6m
4 mm ²	74 m	59 m	44 m	28 m	12m
6 mm ²	110 m	89 m	67 m	42 m	20m

The required conductor cross-section depends on the inverter rating, ambient temperature, routing method, cable type, cable losses, applicable installation requirements of the country of installation, etc.

Residual current protection

The product is equipped with an integrated universal current-sensitive residual current monitoring unit inside. The inverter will disconnect immediately from the mains power as soon as fault current with a value exceeding the limit.



If an external residual-current device is required, install a type B residual-current device which trips at a residual current of 100 mA or higher.

Overvoltage category

The inverter can be used in grids of overvoltage category III or lower in accordance with IEC 60664-1. This means that it can be permanently connected at the grid-connection point in a building. In installations involving long outdoor cable routing, additional measures to reduce overvoltage category IV to overvoltage category III are required.

AC circuit breaker

In PV systems with multiple inverters, protect each inverter with a separate circuit breaker. This will prevent residual voltage being present at the corresponding cable after disconnection.

No consumer load should be applied between AC circuit breaker and the inverter.

The selection of the AC circuit breaker rating depends on the wiring design (wire cross-section area), cable type, wiring method, ambient temperature, inverter current rating, etc.

Derating of the AC circuit breaker rating may be necessary due to self-heating or if exposed to heat.

The maximum output current and the maximum output overcurrent protection of the inverters can be found in section 10 "Technical data".

Grounding conductor monitoring

The inverter is equipped with a grounding conductor monitoring device. This grounding conductor monitoring device detects when there is no grounding conductor connected and disconnects the inverter from the utility grid if this is the case.

Depending on the installation site and grid configuration, it may

be advisable to deactivate the grounding conductor monitoring. This is necessary, for example, in an IT system if there is no neutral conductor present and you intend to install the inverter between two line conductors. If you are uncertain about this, contact your grid operator or AISWEI.



Safety in accordance with IEC 62109 when the grounding conductor monitoring is deactivated.

In order to guarantee safety in accordance with IEC 62109 when the grounding conductor monitoring is deactivated, carry out one of the following measures:

- Connect a copper-wire grounding conductor with a cross-section of at least 10 mm² to the AC connector bush insert.
- Connect an additional grounding that has at least the same cross-section as the connected grounding conductor to the AC connector bush insert. This prevents touch current in the event of the grounding conductor on the AC connector bush insert failing.

6.4.2 Grid connection

Procedure:

DANGER

Danger to life due to high voltages in the inverter

Touching the live components can lead to lethal electric shocks.

- Before performing the electrical connection, ensure that the AC circuit-breaker is switched off and cannot be reactivated.

1. Switch off the miniature circuit-breaker and secure it against being inadvertently switched back on.
2. Insert the conductor into a suitable ferrule acc. to DIN 46228-4 and crimp the contact.

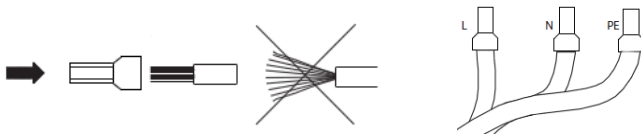

NOTICE

Damage to the inverter due to wrong wiring

If the phase line was connected to PE terminal, the inverter will not function properly.

- Please ensure that the type of the conductors matches the signs of the terminals on the socket element.

3. Unscrew the swivel nut from the threaded sleeve, then thread the swivel nut and threaded sleeve over the AC cable.

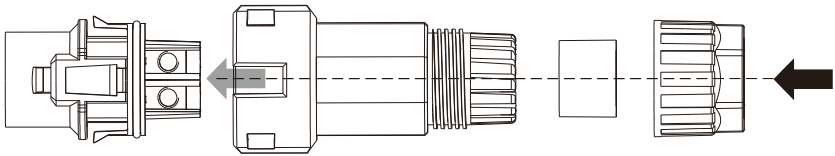

4. Insert the crimped conductors L, N and PE into the corresponding terminals and tighten the screw with a accompanied Torx screwdriver(TX 8, torque: 1.4Nm). Ensure that all conductors are securely in place in the screw terminals on the bush insert. Assemble the locking cap, threaded sleeve and swivel nut together.

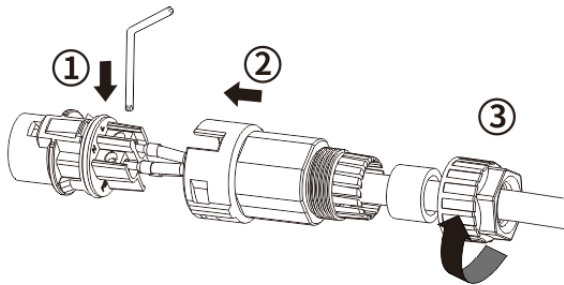

5. Plug the AC connector into the jack for the AC connection and screw tight.

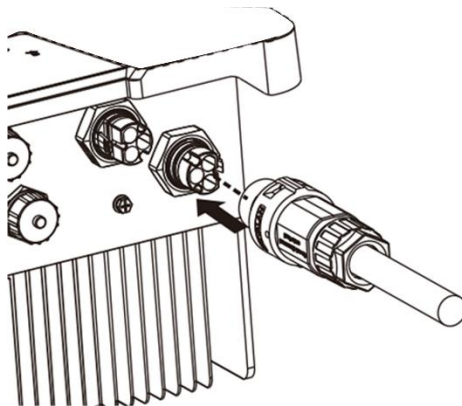

6.5 EPS connection

⚠ DANGER

- All electrical installations must be done in accordance with all local and national rules.
- Make sure that all DC switches and AC circuit breakers have been disconnected before establishing electrical connection. Otherwise, the high voltage within the inverter may lead to electrical shock.
- In accordance with safety regulations, the inverter need be grounded firmly. When poor ground connection (PE) occurs, the inverter will report PE grounding error. Please check and ensure that the inverter is grounded firmly or contact AISWEI service.

Procedure:

1. AC cable requirements are as follows. Insert the conductor into a suitable ferrule acc. to DIN 46228-4 and crimp the contact.

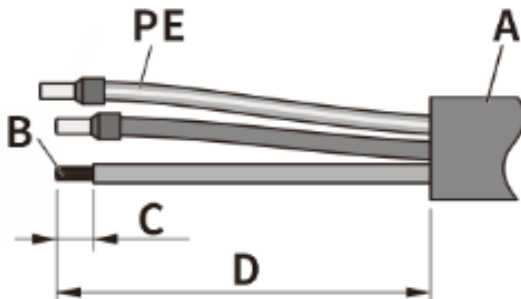

Object	Description	Value
A	External diameter	10-16mm
B	Copper conductor cross-section	2.5-6mm ²
C	Stripping length of the insulated conductors	13mm
D	Stripping length of the cable outer sheath	53mm

The PE conductor must be 2 mm longer than the L and N conductors.

2. Loosen the swivel nut of AC connector. Insert the crimped conductors into corresponding terminals and tighten screws with the accompanied wrench tool (Torque: 1.4Nm). Insert the adapter to the socket element, stuff the sealing sleeve into the adapter and tighten the swivel nut.

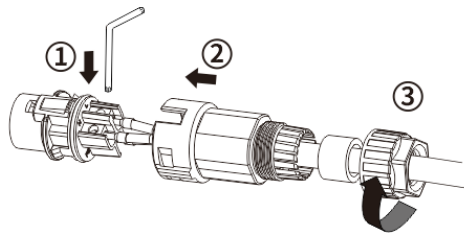

3. Plug the AC connector into the socket for the EPS connection.

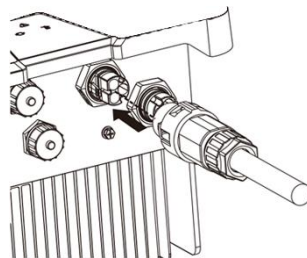

WARNING

Risk of injury due to electric shock when you touch the connector on machine side that don't be connected a client connector.

- Make sure the client connector is installed correctly.
- Make sure the client connector also is installed correctly even you don't need connect the wire to the EPS port.

6.6 Second protective grounding connection

If additional grounding or equipotential bonding is required locally, you can connect additional grounding to the inverter. This prevents touch current if the grounding conductor on the AC connector fails.

Procedure:

1. Insert the grounding conductor into the suitable terminal lug and crimp the contact.
2. Align the terminal lug with the grounding conductor.
3. Insert the screw through the hole located at the housing and tighten it firmly (screwdriver type: PH2, torque: 1.6Nm).

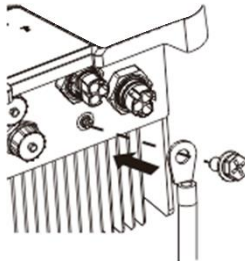

Grounding parts information:

No.	Description
1	Housing
2	Terminal lug (M4) with protective conductor (customer prepared)
3	M4×10 screw

6.7 DC Connection



Danger to life due to high voltages in the inverter

Touching the live components can lead to lethal electric shocks.

- Before connecting the PV array, ensure that the DC switch is switched off and that it cannot be reactivated.
- Do not disconnect the DC connectors under load.

6.7.1 Requirements for the DC Connection

Requirements for the PV modules of a string:

- PV modules of the connected strings must be of: the same type, identical alignment and identical tilt.
- The thresholds for the input voltage and the input current of the inverter must be adhered to (see Section 10.1 "Technical DC input data").
- On the coldest day based on statistical records, the open-circuit voltage of the PV array must never exceed the maximum input voltage of the inverter.

- The connection cables of the PV modules must be equipped with the connectors included in the scope of delivery.
- The positive connection cables of the PV modules must be equipped with the positive DC connectors. The negative connection cables of the PV modules must be equipped with the negative DC connectors.

6.7.2 Assembling the DC connectors

DANGER

Danger to life due to high voltages on DC conductors

When exposed to sunlight, the PV array generates dangerous DC voltage which is present in the DC conductors. Touching the DC conductors can lead to lethal electric shocks.

- Cover the PV modules.
- Do not touch the DC conductors.

Assemble the DC connectors as described below. Be sure to observe the correct polarity. The DC connectors are marked with the symbols "+" and " - ".

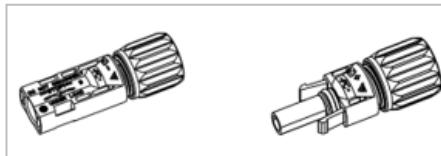

Procedure:

1. DC cable requirements as follows:

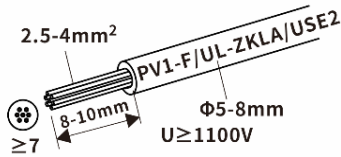

2. Crimp the contacts with the corresponding cables. Crimping tool: H4TC0001, AMPHENOL

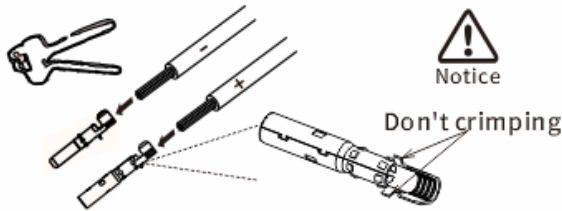

3. Insert the contact cable assembly into back of the corresponding DC plug connector. A "click" should be heard or felt when the contact cable assembly is seated correctly and tighten the swivel nut. (Torque: 2.5Nm).

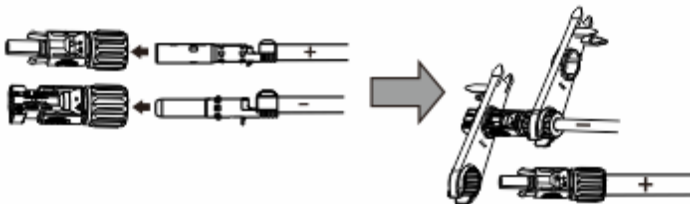

NOTICE

The inverter can be destroyed by overvoltage

If the voltage of the strings exceeds the maximum DC input voltage of the inverter, it can be destroyed due to overvoltage. All warranty claims become void.

- Do not connect strings with an open-circuit voltage greater than the maximum DC input voltage of the inverter.
- Check the design of the PV system.

Procedure:

1. Ensure that the individual AC circuit breaker is switched off and secure it against reconnection.
2. Ensure that the DC-switch is switched off and secure it against reconnection.
3. Ensure that there is no ground fault in the PV strings.
4. Check whether the DC connector has the correct polarity. If the DC connector fits with a DC cable having the wrong polarity, the DC connector must be reassembled again. The DC cable must always have the same polarity as the DC connector.
5. Ensure that the open-circuit voltage of the PV strings does not exceed the maximum DC input voltage of the inverter.

6. Connect the assembled DC connectors to the inverter until they audibly snap into place.

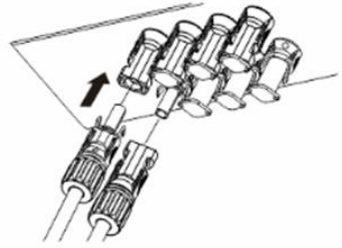

NOTICE

Damage to the inverter due to moisture and dust penetration

Seal the unused DC inputs with sealing plugs so that moisture and dust cannot penetrate the Inverter.

- Make sure all DC connectors are securely sealed.

7. Before DC connection, insert the DC plug connectors with sealing plugs into DC input connectors of the inverter to ensure protection degree.

6.8 Battery connection

Procedure:

! WARNING

Risk of fire due to the electric power

Batteries deliver electric power, resulting in burns or a fire hazard when they are short circuited, or wrongly installed.

- Lead acid batteries are not allowed.
- The lithium battery (pack) must be approved by AISWEI.



Only the approved lithium battery (Pack) can be used. The approved battery mode can be found in Solplanet APP manual.

The information about BMS connection can be found at

1. Cable requirements are as follows. Insert the conductor into a suitable terminal lug and crimp the contact.

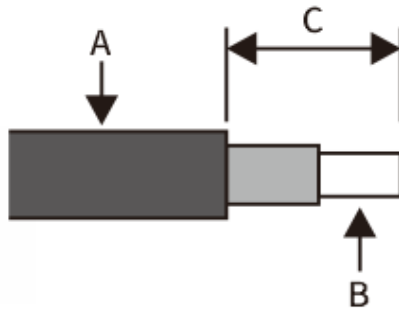

Object	Description	Value
A	External diameter	10-12mm
B	Copper conductor cross-section	20-25mm ²
C	Stripping length of the cable outer sheath	≤55mm

2. Screw the cable terminal lugs to the socket through the battery terminal cover.

Screwdriver type: T30 or SW10, torque: 4.0Nm

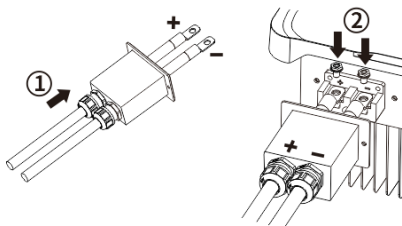

3. Tighten the battery terminal cover and cable gland nuts.
Screwdriver type: PH2, torque: 1.6Nm

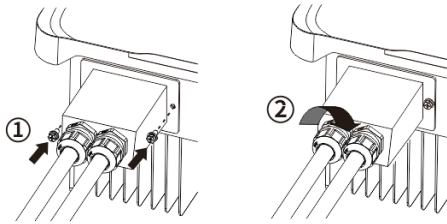

6.9 Communication equipment connection

⚠ DANGER

Danger to life due to electric shock when live components are touched.

- Disconnect the inverter from all voltage sources before connect the network cable.

NOTICE

Damage to the inverter due to electrostatic discharge
Internal components of the inverter can be irreparably damaged by electrostatic discharge.

- Ground yourself before touching any component.

6.9.1 Communication

The communication is divided into four ports, each of which has different functions and can not be connected to the wrong port.

The port distribution is as follows:

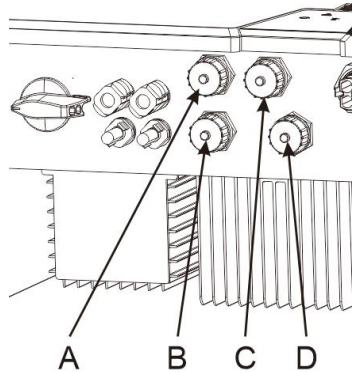

Object	Description
A	BMS: CAN communicate to battery
B	METER: Smart meter system monitoring
C	DRED: Connect the DRMs device
D	COM1: WiFi stick

6.9.2 BMS CAN cable connection

Procedure:

1) RS485 cable pin assignment as below, strip the wire as shown in the figure, and crimp the copper wire to the appropriate OT terminal (according to DIN 46228-4, provided by the customer)

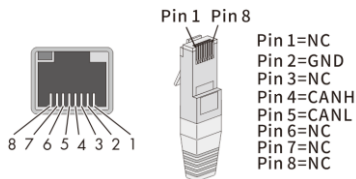

- 2) Unscrew the communication port cover cap in the following arrow sequence and insert the network cable into the RS485 communication client attached.

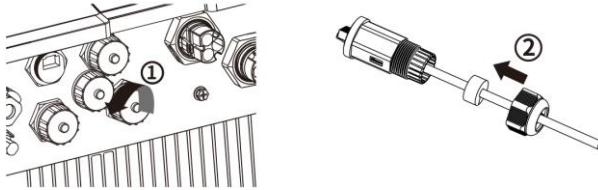

- 3) Insert the network cable into the corresponding communication terminal of the machine according to the arrow sequence, tighten the thread sleeve, and then tighten the forcing nut at the tail.

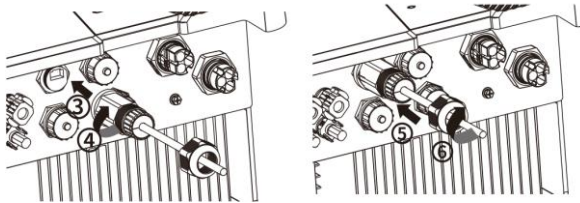

6.9.3 DRED cable connection

Procedure:

- 1) RJ45 cable pin assignment as below, strip the wire as shown in the figure, and crimp the copper wire to the appropriate OT terminal (according to DIN 46228-4, provided by the customer)

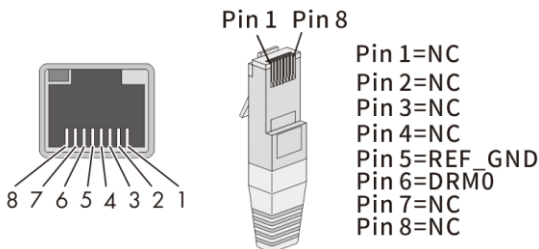

- 2) Unscrew the communication port cover cap in the following arrow sequence and insert the network cable into the RJ45 communication client attached.

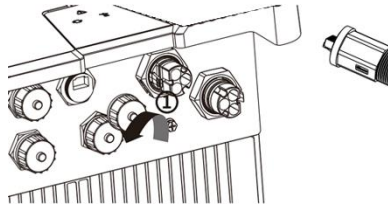

- 3) Insert the network cable into the corresponding communication terminal of the machine according to the arrow sequence, tighten the thread sleeve, and then tighten the forcing nut at the tail.

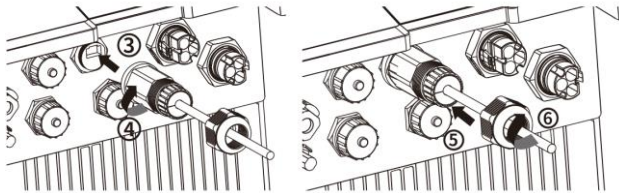

6.9.4 Smart meter cable connection

Connection diagram

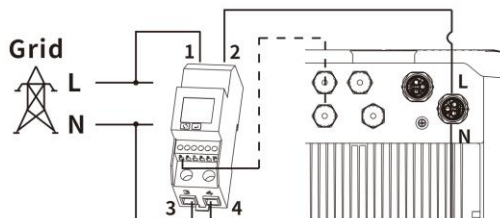

Procedure:

1. Smart meter communication

- 1) RS485 cable pin assignment as below, strip the wire as shown in the figure, and crimp the copper wire to the appropriate OT terminal (according to DIN 46228-4, provided by the customer)

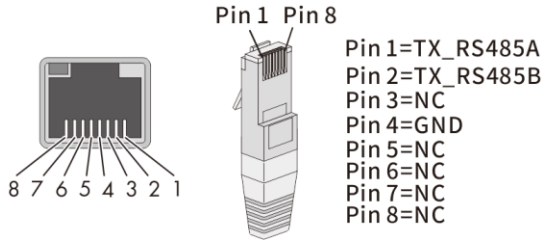

- 2) Unscrew the communication port cover cap in the following arrow sequence and insert the network cable into the RS485 communication client attached.

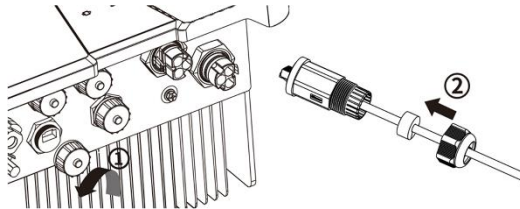

- 3) Insert the network cable into the corresponding communication terminal of the machine according to the arrow sequence, tighten the thread sleeve, and then tighten the forcing nut at the tail.

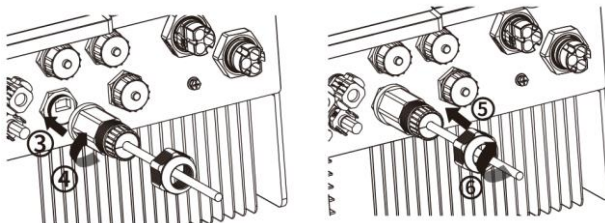

- 4) Insert the other end cable conductors into the slots of smart meter and tighten them. Screwdriver type: PH0, torque: 0.7Nm

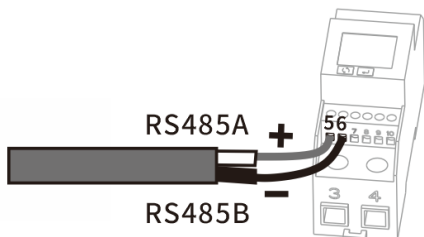

6.9.5 WiFi connection

1. Take out the WiFi/4G modular included in the scope of delivery.
2. Attach the WiFi modular to the connection port in place and tighten it into the port by hand with the nut in the modular. Make sure the modular is securely connected and the label on the modular can be seen.

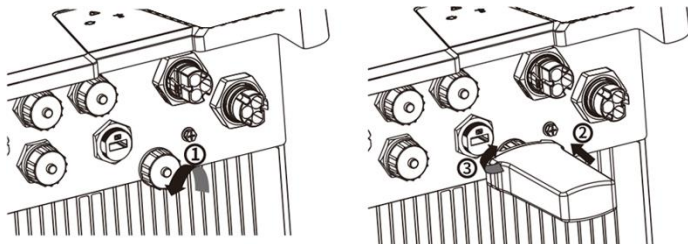

7 Communication

7.1 System monitoring via WLAN

User can monitor the inverter through the Internal WiFi integration. The connection diagram between the inverter and internet with a WLAN connection is shown as follows.

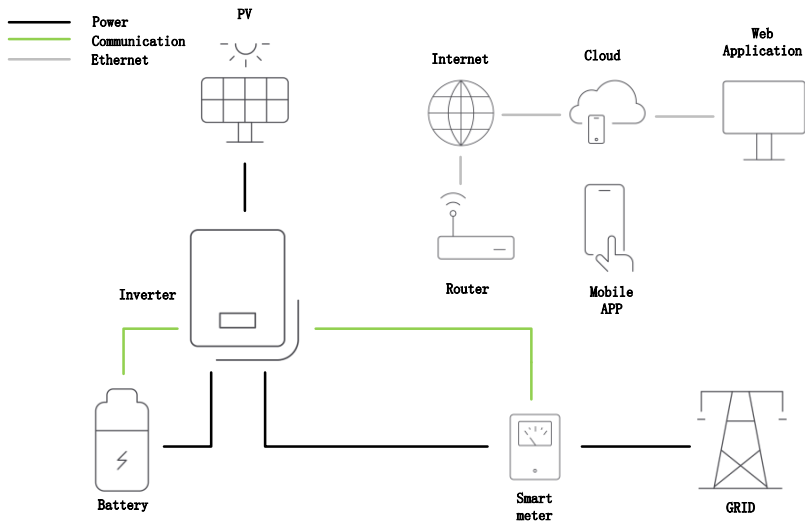

We offer a remote monitoring app called “Solplanet”. You can install the “Solplanet” application on a smart phone using Android or an iOS operating systems.

You can also visit the website (<http://www.solplanet.net>) to download the APP and user manual.

7.2 Inverter demand response modes (DRED)



DRMS application description

- Only applicable to AS/NZS4777.2:2020.
- DRM0 is available.

The inverter shall detect and initiate a response to all supported demand response commands , demand response modes are described as follows:

Mode	Requirement
DRM 0	Operate the disconnection device

The RJ45 socket pin assignments for demand response modes as follows:

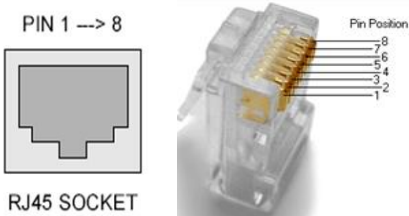
Pin1----- DRM 1/5	
Pin2----- DRM 2/6	
Pin3----- DRM 3/7	
Pin4----- DRM 4/8	
Pin5----- RefGen	
Pin6----- Com/DRM0	
Pin7-----N/A	
Pin8----- N/A	

7.3 Earth Fault Alarm

This inverter complies with IEC 62109-2 clause 13.9 for earth fault alarm monitoring. If an Earth Fault Alarm occurs, the red color LED indicator will light up. At the same time, the error code 38 will be sent to the AISWEI Cloud.

(This function is only available in Australia and New Zealand)

8 Commissioning

8.1 Electrical checks

Carry out the main electrical tests as follows:

- ① Check the PE connection with a multimeter: make sure that the inverter's exposed metal surface has a ground connection.

CAUTION

Danger to life due to the presence of DC Voltage
Touching the live conductors can lead to lethal electric shocks.

- Only touch the insulation of the PV array cables.
- Do not touch parts of the sub-structure and frame of the PV array which isn't grounded.
- Wear personal protective equipment such as insulating gloves.

- ② Check the DC voltage values: check that the DC voltage of the strings does not exceed the permitted limits. Refer to the Section 2.1 "Intended use" about designing the PV system for the maximum allowed DC voltage.
- ③ Check the polarity of the DC voltage: make sure the DC voltage has the correct polarity.

- ④ Check the PV array's insulation to ground with a multimeter:
make sure that the insulation resistance to ground is greater than 1 MOhm.

 **CAUTION**

Danger to life due to the presence of AC Voltage
Touching the live conductors can lead to lethal electric shocks.

- Only touch the insulation of the AC cables.
- Wear personal protective equipment such as insulating gloves.

- ⑤ Check the grid voltage: check that the grid voltage at the point of connection of the inverter complies with the permitted value.
- ⑥ Check the battery voltage: check that the battery voltage at the point of connection of the inverter complies with the permitted value.
- ⑦ Check the polarity of the battery voltage: make sure the battery voltage has the correct polarity.
- ⑧ Check the battery communication connection : Check the battery BMS communication cable connection is normal.

- ⑨ Check the meter connection : Ensure that the meter is connected according to the meter connection diagram, and the wiring sequence and direction are correct.
- ⑩ Check the meter communication connection : Make sure the meter communication connection is correct.

8.2 Mechanical checks

Carry out the main mechanical checks to ensure the inverter is waterproof:

- ① Make sure the inverter has been correctly mounted with wall bracket.
- ② Make sure the cover has been correctly mounted.
- ③ Make sure the communication cable and AC connector have been correctly wired and tightened.

8.3 Safety code check

After finishing the electrical and mechanical checks, switch on the DC-switch. Choose suitable safety code according to the location of installation. Please visit website (www.solplanet.net) and download the Solplanet APP manual for detailed information. you can check the Safety Code Setting and the Firmware Version on APP.



The Solplanet's inverters comply with local safety code when leaving the factory.

For the Australian market, the inverter cannot be connected to the grid before the safety-related area is set. Please select from Australia Region A/B/C and New Zealand to comply with AS/NZS 4777.2:2020, and contact your local electricity grid operator on which Region to select.

8.4 Start-Up

After finishing the electrical and mechanical checks, switch on the miniature circuit-breaker, DC-switch and battery-switch in turn. Once the DC input voltage is sufficiently high, the battery voltage is within the operation range and the grid-connection conditions are met, The inverter will enter the waiting state.

8.4.1 Smart meter set-up

It is necessary to set the communication format of smart meter to 8N1 and baud rate to 9600. For smart meter settings, please refer to the smart meter manual.

8.4.2 Initialization set-up

Download the Solplanet application, and then you need to set the battery model, working mode, electricity meter and safety regulation on the app. After setting, click the start device button.

The inverter will enter the working. For Solplanet application operation, please refer to the application manual

You can also visit the website (<http://www.solplanet.net>) to download the APP and user manual.

8.4.3 Starting conditions of different modes

Starting conditions of different modes

It cannot be switched on when PV and AC are alone

8.4.4 Description of working state

Usually, there are three states during operation:

Waiting: when the inverter does not meet the requirements of each mode (When the initial voltage of the strings is greater than the minimum DC input voltage but lower than the start-up DC input voltage, battery voltage lower than the start-up battery input voltage or BMS communication not connect) the inverter is waiting for sufficient DC input voltage and cannot feed power into the grid.

Checking: When the inverter meets the start-up conditions of each mode. the inverter will check feeding conditions at once. If there is anything wrong during checking, the inverter will switch to the "Fault" mode.

Normal: After checking, the inverter will switch to "Normal" state and feed power into the grid.

During periods of low radiation, the inverter may continuously start up and shut down. This is due to insufficient power generated by the PV array.

If this fault occurs often, please call service.



If the inverter is in "Fault" mode, refer to Section 11 "**Troubleshooting**".

9 Display







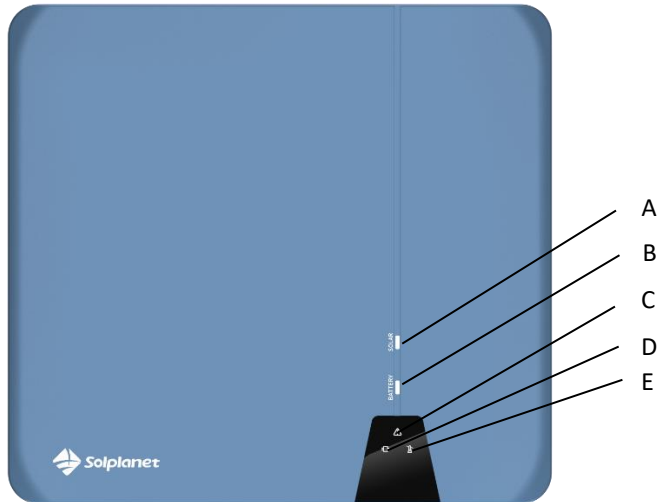





The information provided here covers the LED indicators.

9.1 Overview of the panel

The inverter is equipped with five LEDs indicators.



Object	Function	Diagram	LED	Description
A	SOLAR		ON	PV active
			BLINK	Self-check/Soft upgrade
			OFF	PV not active
B	BAT		ON	Battery active
			BLINK	Self-check/Soft upgrade/SOC low
			OFF	Battery not active
C	ERR		YELLOW ON	Cloud communication fault

			YELLOW BLINK	Warning
			RED ON	Fault
			OFF	Normal work
D	EPS		WHITE ON	EPS output with load
			WHITE BLINK	EPS output without load
			RED ON	EPS output fault
			RED BLINK	EPS output overload
			OFF	EPS without output
E	GRID		WHITE ON	Grid is active and connected
			WHITE BLINK	Grid is active, Forced off-grid
			RED ON	Grid fault
			OFF	Inverter shutdown

9.1.1 LEDs

The inverter is equipped with five LED indicators “white”, “white”, “yellow/red”, “white/red” and “white/red” which provide information about the various operating states.

solar LED:

The white LED is lit when the PV current of any channel is greater than 0.5A The white LED is flashes The inveter is self-check or software update. The white LED is off The PV is not working.

BAT LED:

The white LED is lit when the BAT is operating normally at least one. The white LED is flashes The inveter is self-check or software update or battery SOC lower. The white LED is off The BAT is not working.

ERR LED:

The yellow LED is lit When the communication between combox and cloud is abnormal. The yellow LED is flashes When the inverter is warning . The red LED is lit When the inverter is faluty . The ERR LED always off when the inverter is operating normally

EPS LED:

The white LED is lit when the EPS is operating normally on-load. The white LED is flashes The EPS is operating normally no-load. The red LED is lit The EPS is faulty. The red LED is flashes The EPS is over load.The EPS LED always off when EPS no output voltage.

GRID LED:

The white LED is lit when the GRID is operating normally. The white LED is flashes The inveter is operating forced off grid. The red LED is lit when the GRID is faulty. The GRID LED is off The inverter is not working.

10 Disconnecting the Inverter from Voltage Sources

Before performing any work on the inverter, disconnect it from all voltage sources as described in this section. Always adhere strictly to the given sequence.

1. Disconnect AC circuit breaker and secure against reconnection.
2. Disconnect the DC-switch and secure against reconnection.
3. Turn off the battery switch or button to stop the battery output.
4. Use a current probe to ensure that no current is present in the DC cables.

DANGER

Danger to life due to electric shock when touching exposed DC conductors or DC plug contacts if the DC connectors are damaged or loose

The DC connectors can break or become damaged, become free of the DC cables, or no longer be connected correctly if the DC connectors are released and disconnected incorrectly. This can result in the DC conductors or DC plug contacts being exposed. Touching live DC conductors or DC plug connectors will result in death or serious injury due to electric shock.

- Wear insulated gloves and use insulated tools when working on the DC connectors.
- Ensure that the DC connectors are in perfect condition and that none of the DC conductors or DC plug contacts are exposed.
- Carefully release and remove the DC connectors as described in the following.

5. Release and remove all DC connectors. The DC connector can be gently unplugged by inserting the mounting bayonet shown in the figure below with a dismounting wrench and pressing down firmly. Make sure the DC switch is in the "OFF" position before operation.

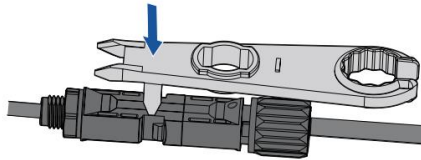

6. Release and disconnect the AC connector. Rotate the socket element counter-clockwise to open.

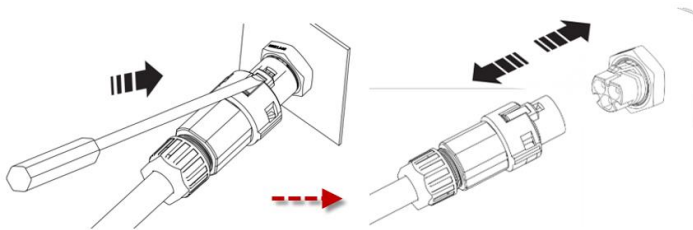

7. Release and disconnect the EPS connector. Rotate the socket element counter-clockwise to open.

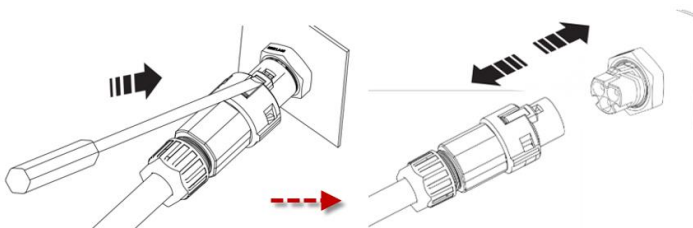

8. Wait until all LEDs and the display have gone out.

11 Technical Data

11.1 DC input data

Type	ASW300 0H-S2	ASW368 0H-S2	ASW400 0H-S2	ASW500 0H-S2	ASW600 0H-S2
Max. PV array power(STC)	5500Wp	6180Wp	6500Wp	7500Wp	9000Wp
Max. input voltage	550V				
MPP voltage range	40V-530V				
Rated input voltage	380V				
Initial feeding-in voltage	50V				
Min. feed-in power	20W				
Max. input current per MPP input	16A				
Isc PV(absolute maximum)	20A				
Number of independent MPP inputs	2				
Strings per MPP input	1				
Max. inverter backfeed current to the array	0A				

11.2 Battery input data

Type	ASW300	ASW368	ASW400	ASW500	ASW600
	0H-S2	0H-S2	0H-S2	0H-S2	0H-S2
Nominal battery voltage	48V				
Battery voltage range	40V-60V				
Max charging power	5000W				
Max discharging power	5000W				
Max charging current	100A				
Max discharging current	100A				

11.3 Grid AC output data

Type	ASW300 0H-S2	ASW368 0H-S2	ASW400 0H-S2	ASW500 0H-S2	ASW600 0H-S2
Rated active power	3000W	3680W	4000W	5000W	6000W
Rated apparent power	3000VA	3680VA	4000VA	5000VA	6000VA
Max. apparent power	3000VA	3680VA	4000VA	5000VA	6000VA
Rated voltage/ range	220V,230V /160V-300V				
Rated frequency/ range	50, 60/±5Hz				
Max. output current	13.6A	16A	18.2A	22.7A	27.3 A
Max. output fault current	36A	36A	36A	36A	36A
Max. output over-current protection	48A	48A	48A	48A	48A
Inrush current	10A/250us				
Power factor (@rated power)	1				
Adjustable displacement power factor	0.8 inductive.... 0.8 capacitive				
Feed-in phase / connection phase	1/1				
Harmonic distortion (THD) at rated output	<3%				

11.4 Grid AC input data

Type	ASW300 0H-S2	ASW368 0H-S2	ASW400 0H-S2	ASW500 0H-S2	ASW600 0H-S2
Rated active power	6000W				
Rated apparent power	6000VA				
Max. apparent power	6000VA				
Rated voltage/ range	220V,230V /180V-280V				
Rated frequency/ range	50, 60/±5Hz				
Max. input current	27.3A				
Max. output fault current	36A				
Max. output over-current protection	48A				
Feed-in phase / connection phase	1/1				

11.5 EPS output data

Type	ASW300	ASW368	ASW400	ASW500	ASW600
	0H-S2	0H-S2	0H-S2	0H-S2	0H-S2
Max output apparent power	5000VA				
Peak output apparent power	7500VA/10s				
Nominal output voltage	230V				
Nominal output frequency	50Hz/60Hz				
Max output current	21.7A				
Max switch time	10ms				
Output THDv (@ Linear load)	<3%				

11.6 General data

General data	ASW3000H-S2/ 3680H-S2 / 4000H-S2 / 5000H-S2/ 6000H-S2
communication	WIFI
Display	LED
Zero power output	Via connecting Smart meter
Dimensions (W x H x D mm)	483 x 455 x 193.5 mm
Weight	25.1kg
Cooling concept	convection
Noise emission (typical)	< 25 dB(A)@1m
Installation	indoor & outdoor
Mounting information	wall mounting bracket
DC connection technology	SUNCLIX
AC connection technology	Plug-in Connector
Operating temperature range	-25°C...+60°C
Relative humidity (non-condensing)	0% ... 100%
Max. operating altitude	4000m(>3000m derating)
Degree of protection	IP66 (according to IEC 60529)
Climatic category	4K4H (according to IEC60721-3-4)
Topology	Non-Isolated
Self-consumption (night)	<10W
Communication interfaces	WiFi
Radio technology	WLAN 802.11 b / g / n
Radio spectrum	WLAN with 2412 – 2472MHz band
Antenna gain	2dBi

11.7 Safety regulations

Protective devices	ASW3000H-S2/ 3680H-S2 / 4000H-S2 / 5000H-S2/ 6000H-S2
DC isolator	●
PV iso / Grid monitoring	● / ●
DC reverse polarity protection / AC short- circuit current capability	● / ●
Residual current monitoring (GFCI) function	●
Earth Fault Alarm	cloud based, visible(AU)
Protection class (according to IEC 62103) / overvoltage category (according to IEC 60664-1)	I / II(DC), III(AC)
Internal overvoltage protection	Integrated
DC feed-in monitoring	Integrated
Islanding protection	Integrated (active method, active frequency drift (AFD) method)
EMC immunity	EN61000-6-1, EN61000-6-2, ETSI EN301489-17
EMC emission	EN61000-6-3, EN61000-6-4, ETSI EN301489-1
Utility interference	EN61000-3-2, EN61000-3-3 EN61000-3-11, EN61000-3-12

●—Standard

○—Optional

—N/A

11.8 Efficiency

The operating efficiency is shown for the three input voltages ($V_{mpphigh}$, $V_{dc,r}$ and V_{mpplow}) graphically. In all cases the efficiency refers to the standardized power output ($P_{ac}/P_{ac,r}$). (according to EN 50524 (VDE 0126-13): 2008-10, cl. 4.5.3).

Notes: Values are based on rated grid voltage, $\cos(\phi) = 1$ and an ambient temperature of 25°C.

Efficiency curve ASW3000H-S2



Efficiency	
Max. efficiency / European weighted efficiency	96.8% / 95.6%
MPPT efficiency	99.9%

Efficiency curve ASW3680H-S2



Efficiency	
Max. efficiency / European weighted efficiency	96.8% / 95.6%
MPPT efficiency	99.9%

Efficiency curve ASW4000H-S2



Efficiency	
Max. efficiency / European weighted efficiency	96.8% / 96.1%
MPPT efficiency	99.9%

Efficiency curve ASW5000H-S2



Efficiency	
Max. efficiency / European weighted efficiency	96.8% / 96.3%
MPPT efficiency	99.9%

Efficiency curve ASW6000H-S2

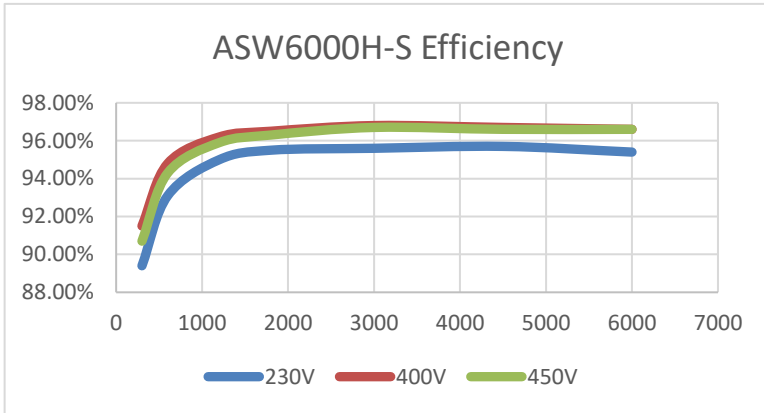

Efficiency	
Max. efficiency / European weighted efficiency	96.8% / 96.4%
MPPT efficiency	99.9%

Discharge Efficiency curve ASW3000H-S2/ ASW3680H-S2/ ASW4000H-S2/ ASW5000H-S2/ 6000H-S2

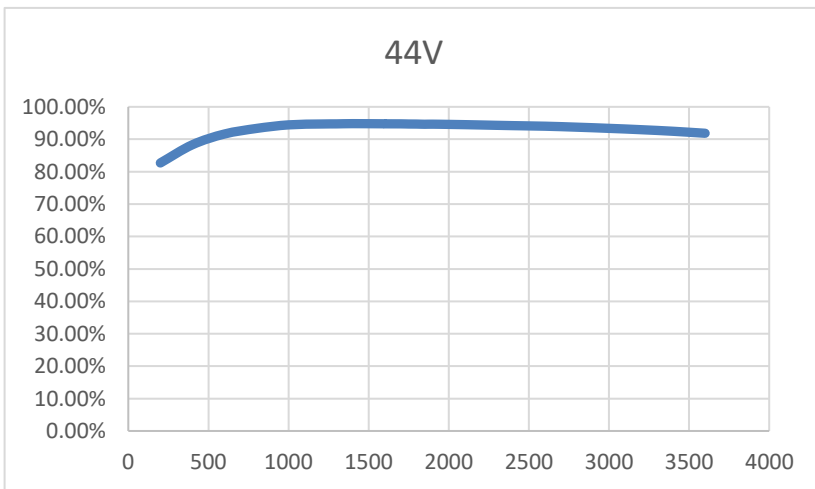

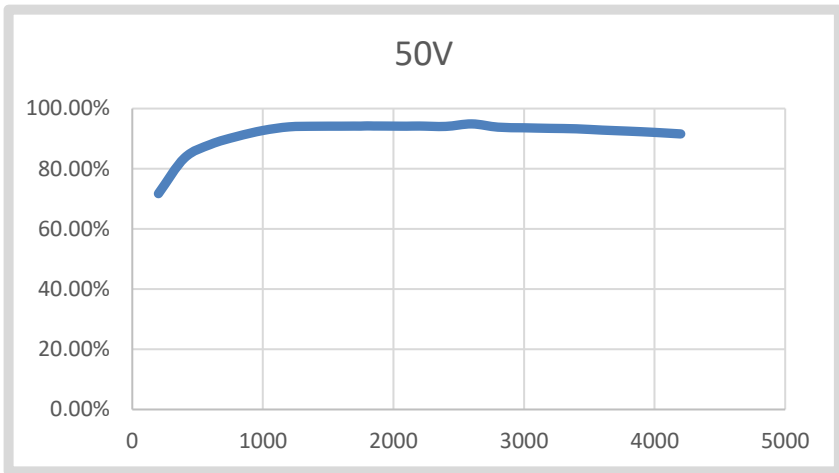

Efficiency	
MAX efficiency	94.82%

11.9 Power reduction

In order to ensure inverter operation under safe conditions, the device may automatically decrease power output.

Power reduction depends on many operating parameters including ambient temperature and input voltage, grid voltage, grid frequency and power available from the PV modules. This device can decrease power output during certain periods of the day according to these parameters.

Notes: Values are based on rated grid voltage and $\cos(\phi) = 1$.

11.9.1 Power reduction with increased ambient temperature (ASW3000H-S2)

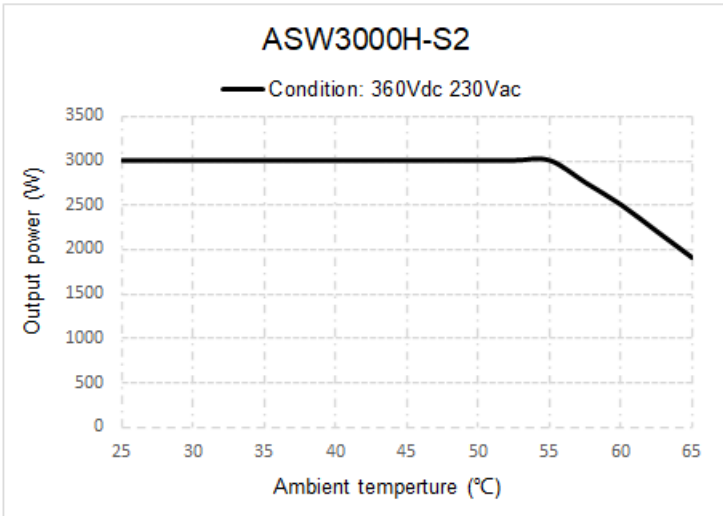

11.9.2 Power reduction with increased ambient temperature (ASW3680H-S2)

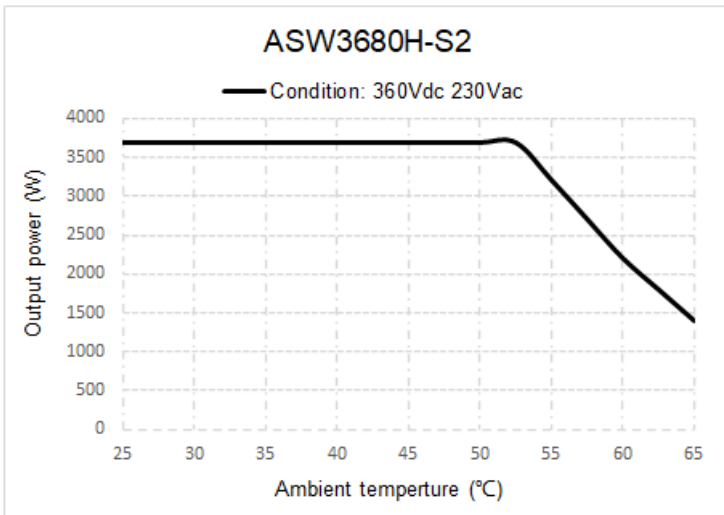

11.9.3 Power reduction with increased ambient temperature (ASW4000H-S2)

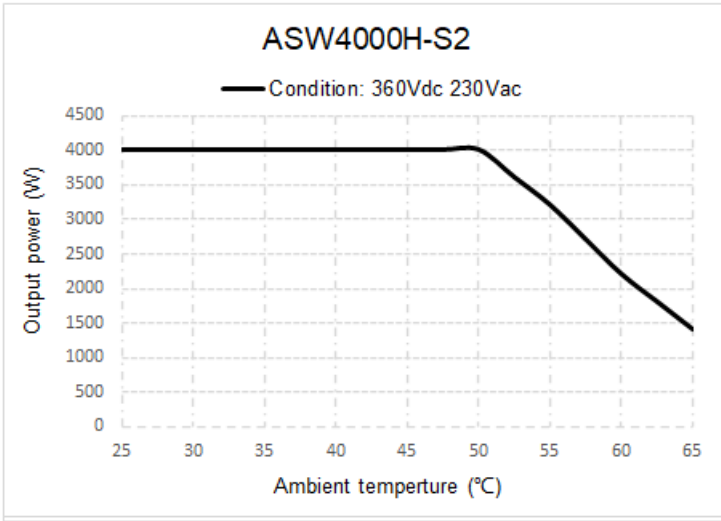

11.9.4 Power reduction with increased ambient temperature (ASW5000H-S2)

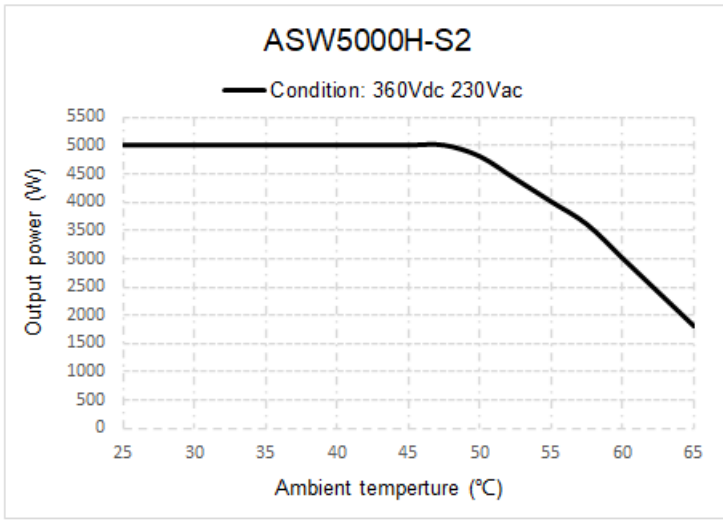

11.9.5 Power reduction with increased ambient temperature (ASW6000H-S2)

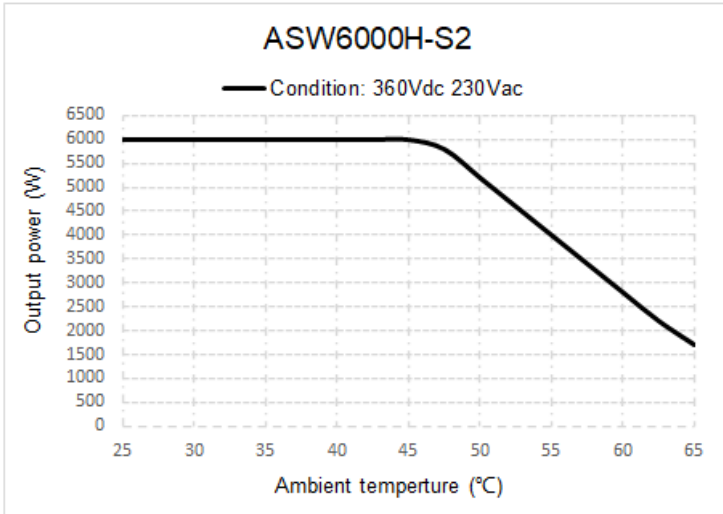

The power reduction curve is tested at normal air pressure!
Different air pressure condition will cause different test result.

11.10 Tools and torque

Tools and torque required for installation and electrical connections.

Tools, model		Object	Torque
Torque screwdriver, T25		Screws for the cover	2.5Nm
Torque screwdriver, T20		Screw for second protective grounding connection	1.6Nm
		Screws for connecting the inverter and wall bracket	
Flat-head screwdriver, blade with 3.5mm		Sunclix DC connector	/
Flat-head screwdriver, blade 0.4x2.5		Smart meter connector	/
/		Stick	Hand-tight
Socket wrench	Open end of 33	Swivel nut of M25 cable gland	Hand-tight
	Open end of 15	Swivel nut of sunclix connector	2.0Nm
Wire stripper		Peel cable jackets	/
Crimping tools		Crimp power cables	/
Hammer drill, drill bit of Ø10		Drill holes on the wall	/
Rubber mallet		Hammer wall plugs into holes	/

Cable cutter	Cut power cables	/
Multimeter	Check electrical connection	/
Marker	Mark the positions of drill holes	/
ESD glove	Wear ESD glove when opening the inverter	/
Safety goggle	Wear safety goggle during drilling holes.	/
Anti-dust respirator	Wear anti-dust respirator during drilling holes.	/

12 Troubleshooting

When the PV system does not operate normally, we recommend the following solutions for quick troubleshooting. If an error occurs, the red LED will light up. There will have "Event Messages" display in the monitor tools. The corresponding corrective measures are as follows:

Object	Error code	Corrective measures
Presumable Fault	6	<ul style="list-style-type: none"> • Check the open-circuit voltages of the strings and make sure it is below the maximum DC input voltage of the inverter. • If the input voltage is within the permitted range and the fault still occurs, it might be that the internal circuit has broken. Contact the service.
	33	<ul style="list-style-type: none"> • Check the grid frequency and observe how often major fluctuations occur. If this fault is caused by frequent fluctuations, try to modify the operating parameters after informing the grid operator first.
	34	<ul style="list-style-type: none"> • Check the grid voltage and grid connection on inverter. • Check the grid voltage at the point of connection of inverter. <p>If the grid voltage is outside the permissible range due to local grid conditions, try to</p>

Presumable Fault		<p>modify the values of the monitored operational limits after informing the electric utility company first.</p> <p>If the grid voltage lies within the permitted range and this fault still occurs, please call service.</p>
	35	<ul style="list-style-type: none"> • Check the fuse and the triggering of the circuit breaker in the distribution box. • Check the grid voltage, grid usability. • Check the AC cable, grid connection on the inverter. <p>If this fault is still being shown, contact the service.</p>
	36	<ul style="list-style-type: none"> • Make sure the grounding connection of the inverter is reliable. • Make a visual inspection of all PV cables and modules. <p>If this fault is still shown, contact the service.</p>
	37	<ul style="list-style-type: none"> • Check the open-circuit voltages of the strings and make sure it is below the maximum DC input voltage of the inverter. <p>If the input voltage lies within the permitted range and the fault still occurs, please call service.</p>
	38	<ul style="list-style-type: none"> • Check the PV array's insulation to ground and make sure that the insulation resistance to ground is greater than 1 MOhm. Otherwise, make a visual

		<p>inspection of all PV cables and modules.</p> <ul style="list-style-type: none"> • Make sure the grounding connection of the inverter is reliable. <p>If this fault occurs often, contact the service.</p>
	40	<ul style="list-style-type: none"> •Check whether the airflow to the heat sink is obstructed. •Check whether the ambient temperature around the inverter is too high.
	41, 42 43, 44 45 47	<ul style="list-style-type: none"> • Disconnect the inverter from the grid and the PV array and reconnect after 3 minutes. <p>If this fault is still being shown, contact the service.</p>
	61 62	Check the DRED device communication or operation
	65	<ul style="list-style-type: none"> •Check if the ground line is connected with the inverter ; • Make sure the grounding connection of the inverter is connected and reliable. <p>If this fault occurs often, contact the service.</p>
Permanent Fault	1, 2,3, 4,5, 6, 8,9	<ul style="list-style-type: none"> • Disconnect the inverter from the utility grid and the PV array and reconnect it after LCD and LED turn off. If this fault is still being displayed, contact the service.

Contact the service if you meet other problems not in the table.

13 Maintenance

Normally, the inverter needs no maintenance or calibration. Regularly inspect the inverter and the cables for visible damage. Disconnect the inverter from all power sources before cleaning. Clean the enclosure with a soft cloth. Ensure the heat sink at the rear of the inverter is not covered.

13.1 Cleaning the contacts of the DC switch

Clean the contacts of the DC switch annually. Perform cleaning by cycling the switch to on and off positions 5 times. The DC switch is located at the lower left of the enclosure.

13.2 Cleaning the heat sink

CAUTION

Risk of injury due to hot heat sink

The heat sink may exceed 70°C during operation. Do not touch the heat sink during operation.

- Wait approx. 30 minutes before cleaning until the heat sink has cooled down.

Clean the heat sink with compressed air or a soft brush. Do not use aggressive chemicals, cleaning solvents or strong detergents.

For proper function and long service life, ensure free air circulation around the heat sink.

14 Recycling and disposal

Dispose of the packaging and replaced parts according to the rules applicable in the country where the device is installed.



Do not dispose the Solplanet inverter with normal domestic waste.



Do not dispose of the product together with the household waste but in accordance with the disposal regulations for electronic waste applicable at the installation site.

15 EU Declaration of Conformity

within the scope of the EU directives

- Electromagnetic compatibility 2014/30/EU (L 96/79-106, March 29, 2014) (EMC).
- Low Voltage Directive 2014/35/EU.(L 96/357-374, March 29, 2014)(LVD).
- Radio Equipment Directive 2014/53/EU (L 153/62-106. May 22. 2014) (RED)



AISWEI Technology Co., Ltd. confirms herewith that the inverters described in this document are in compliance with the fundamental requirements and other relevant provisions of the above mentioned directives. The entire EU Declaration of Conformity can be found at www.solplanet.net.

16 Warranty

The factory warranty card is enclosed with the package, please keep well the factory warranty card. Warranty terms and conditions can be downloaded at www.solplanet.net ,if required. When the customer needs warranty service during the warranty period, the customer must provide a copy of the invoice, factory warranty card, and ensure the electrical label of the inverter is legible. If these conditions are not met, AISWEI has the right to refuse to provide with the relevant warranty service.

17 Contact

If you have any technical problems concerning our products, please contact AISWEI service. We require the following information in order to provide you with the necessary assistance:

- Inverter device type
- Inverter serial number
- Type and number of connected PV modules
- Error code
- Mounting location
- Installation date
- Warranty card

EMEA

Service email: service.EMEA@solplanet.net

APAC

Service email: service.APAC@solplanet.net

LATAM

Service email: service.LATAM@solplanet.net

Aiswei Greater China

Service email: service.china@aiswei-tech.com

Hotline: +86 400 801 9996

Taiwan

Service email: service.taiwan@aiswei-tech.com

Hotline: +886 809089212

<https://solplanet.net/contact-us/>

